

UNAS

hydraulika s.r.o.

Hydraulická šroubení DIN 2353

UNAS hydraulika, s.r.o.
Ratibořská 177
747 05 Opava
tel. /fax: 553 650 06
e-mail: unas@opava.cz
www.hydraulikaunas.cz

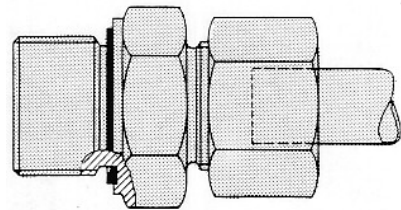
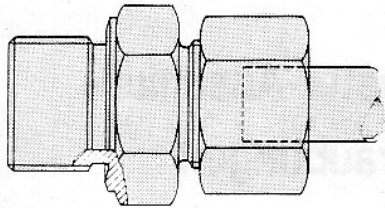

A- přímé hrdlo

A...-/wd - přímé hrdlo s měkkým těsněním

AD	PN	Obj. kód	G	Obj. kód	M	Obj. kód	NPT
4	LL	A 04RLL	R 1/8"K	A 04MLL	M 8x1K	A 04LL/NPT	1/8"NPT
6	100	A 06RLL	R 1/8"K	A 06MLL	M 10x1K	A 06LL/NPT	1/8"NPT
8		A 08RLL	R 1/8"K	A 08MLL	M 10x1K	A 08LL/NPT	1/8"NPT
6	L 500	A 06RLWD	G 1/8"	A 06MLWD	M 10x1	A 06L/NPT	1/8"NPT
8		A 08RLWD	G 1/4"	A 08MLWD	M 12x1,5	A 08L/NPT	1/4"NPT
10		A 10RLWD	G 1/4"	A 10MLWD	M 14x1,5	A 10L/NPT	1/4"NPT
12		A 12RLWD	G 3/8"	A 12MLWD	M 16x1,5	A 12L/NPT	3/8"NPT
15	L 400	A 15RLWD	G 1/2"	A 15MLWD	M 18x1,5	A 15L/NPT	1/2"NPT
18		A 18RLWD	G 1/2"	A18MLWD	M 22x1,5	A 18L/NPT	1/2"NPT
22	L 250	A 22RLWD	G 3/4"	A 22MLWD	M 26x1,5	A 22L/NPT	3/4"NPT
28		A 28RLWD	G 1"	A 28MLWD	M 33x2	A 28L/NPT	1"NPT
35		A 35RLWD	G 1 1/4"	A 35MLWD	M 42x2	A 35L/NPT	1 1/4"NPT
42		A 42RLWD	G 1 1/2"	A 42MLWD	M 48x2	A 42L/NPT	1 1/2"NPT
6	S 800	A 06RSWD	G 1/4"	A 06MSWD	M 12x1,5	A 06S/NPT	1/4"NPT
8		A 08RSWD	G 1/4"	A 08MSWD	M 14x1,5	A 08S/NPT	1/4"NPT
10		A 10RSWD	G 3/8"	A 10MSWD	M 16x1,5	A 10S/NPT	3/8"NPT
12	S 630	A 12RSWD	G 3/8"	A 12MSWD	M 18x1,5	A 12S/NPT	3/8"NPT
14		A 14RSWD	G 1/2"	A14MSWD	M 20x1,5	A 14S/NPT	1/2"NPT
16		A 16RSWD	G 1/2"	A 16MSWD	M 22x1,5	A 16S/NPT	1/2"NPT
20	S 400	A 20RSWD	G 3/4"	A 20MSWD	M 27x2	A 20S/NPT	3/4"NPT
25		A 25RSWD	G 1"	A 25MSWD	M 33x2	A 25S/NPT	1"NPT
30		A 30RSWD	G 1 1/4"	A 30MSWD	M 42x2	A 30S/NPT	1 1/4"NPT
38		A 38RSWD	G 1 1/2"	A 38MSWD	M 48x2	A 38S/NPT	1 1/2"NPT

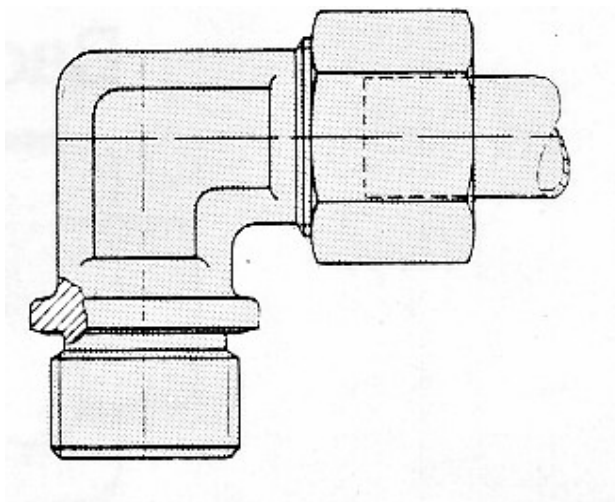

B – úhlové hrdlo

AD	PN	Obj. kód	G	Obj. kód	M	Obj. kód	NPT
4	LL	B 04RLL	R 1/8"K	B 04MLL	M 8x1K	B 04L/NPT	1/8"NPT
6	100	B 06RLL	R 1/8"K	B 06MLL	M 10x1K	B 06L/NPT	1/8"NPT
8		B 08RLL	R 1/8"K	B 08MLL	M 10x1K	B 08L/NPT	1/8"NPT
6	L	B 06RL	R 1/8"K	B 06MLL	M 10x1K	B 06L/NPT	1/8"NPT
8	315	B 08RL	R 1/4"K	B 08MLL	M 12x1,5K	B 08L/NPT	1/4"NPT
10		B 10RL	R 1/4"K	B 10ML	M 14x1,5K	B 10L/NPT	1/4"NPT
12		B 12RL	R 3/8"K	B 12ML	M 16x1,5K	B 12L/NPT	3/8"NPT
15		B 15RL	R 1/2"K	B 15ML	M 18x1,5K	B 15L/NPT	1/2"NPT
18		B 18RL	R 1/2"K	B 18ML	M 22x1,5K	B 18L/NPT	1/2"NPT
22	L	B 22RL	G 3/4"	B 22ML	M 26x1,5	B 22L/NPT	3/4"NPT
28	160	B 28RL	G 1"	B 28ML	M 33x2	B 28L/NPT	1"NPT
35		B 35RL	G 1 1/4"	B 35ML	M 42x2	B 35L/NPT	1 1/4"NPT
42		B 42RL	G 1 1/2"	B 42ML	M 48x2	B 42L/NPT	1 1/2"NPT
6	S	B 06RS	R 1/4"K	B 06MS	M 12x1,5K	B 06S/NPT	1/4"NPT
8	400	B 08RS	R 1/4"K	B 08MS	M 14x1,5K	B 08S/NPT	1/4"NPT
10		B 10RS	R 3/8"K	B 10MS	M 16x1,5K	B 10S/NPT	3/8"NPT
12		B 12RS	R 3/8"K	B 12MS	M 18x1,5K	B 12S/NPT	3/8"NPT
14		B 14RS	R 1/2"K	B 14MS	M 20x1,5K	B 14S/NPT	1/2"NPT
16		B 16RS	R 1/2"K	B 16MS	M 22x1,5K	B 16S/NPT	1/2"NPT
20	S	B 20RS	R 3/4"K	B 20MS	M 27x2	B 20S/NPT	3/4"NPT
25	250	B 25RS	G 1"	B 25MS	M 33x2	B 25S/NPT	1"NPT
30	S	B 30RS	G 1 1/4"	B 30MS	M 42x2	B 30S/NPT	1 1/4"NPT
38	160	B 38RS	G 1 1/2"	B 38MS	M 48x2	B 38S/NPT	1 1/2"NPT

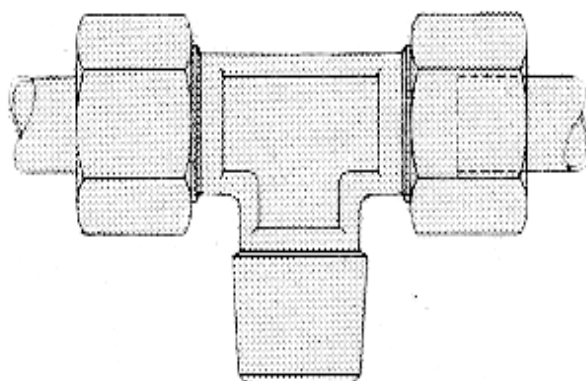

C – T hrdlo

AD	PN	Obj. kód	G	Obj. kód	M	Obj. kód	NPT
4	LL	C 04RLL	R 1/8"K	C 04MLL	M 8x1K	C 04LL/NPT	1/8"NPT
6	100	C 06RLL	R 1/8"K	C 06MLL	M 10x1K	C 06LL/NPT	1/8"NPT
8		C 08RLL	R 1/8"K	C 08MLL	M 10x1K	C 08LL/NPT	1/8"NPT
6		C 06RL	R 1/8"K	C 06ML	M 10x1K	C 06L/NPT	1/8"NPT
8	L	C 08RL	R 1/4"K	C 08ML	M 12x1,5K	C 08L/NPT	1/4"NPT
10	315	C 10RL	R 1/4"K	C 10ML	M 14x1,5K	C 10L/NPT	1/4"NPT
12		C 12RL	R 3/8"K	C 12ML	M 16x1,5K	C 12L/NPT	3/8"NPT
15		C 15RL	R 1/2"K	C 15ML	M 18x1,5K	C 15L/NPT	1/2"NPT
18		C 18RL	R 1/2"K	C 18ML	M 22x1,5K	C 18L/NPT	1/2"NPT
22		C 22RL	G 3/4"	C 22ML	M 26x1,5	C 22L/NPT	3/4"NPT
28	L	C 28RL	G 1"	C 28ML	M 33x2	C 28L/NPT	1"NPT
35	160	C 35RL	G 1 1/4"	C 35ML	M 42x2	C 35L/NPT	1 1/4"NPT
42		C 42RL	G 1 1/2"	C 42ML	M 48x2	C 42L/NPT	1 1/2"NPT
6		C 06RS	R 1/4"K	C 06MS	M 12x1,5K	C 06S/NPT	1/4"NPT
8		C 08RS	R 1/4"K	C 08MS	M 14x1,5K	C 08S/NPT	1/4"NPT
10	S	C 10RS	R 3/8"K	C 10MS	M 16x1,5K	C 10S/NPT	3/8"NPT
12	400	C 12RS	R 3/8"K	C 12MS	M 18x1,5K	C 12S/NPT	3/8"NPT
14		C 14RS	R 1/2"K	C 14MS	M 20x1,5K	C 14S/NPT	1/2"NPT
16		C 16RS	R 1/2"K	C 16MS	M 22x1,5K	C 16S/NPT	1/2"NPT
20	S	C 20RS	R 3/4"K	C 20MS	M 27x2	C 20S/NPT	3/4"NPT
25	250	C 25RS	G 1"	C 25MS	M 33x2	C 25S/NPT	1"NPT
30	S	C 30RS	G 1 1/4"	C 30MS	M 42x2	C 30S/NPT	1 1/4"NPT
38	160	C 38RS	G 1 1/2"	C 38MS	M 48x2	C 38S/NPT	1 1/2"NPT

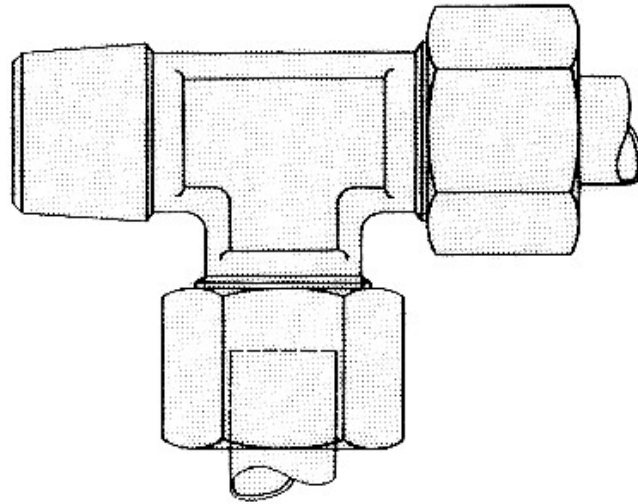

D – T hrdlo

AD	PN	Obj. kód	G	Obj. kód	M	Obj. kód	NPT
4	LL	D 04RLL	R 1/8"K	D 04MLL	M 8x1K	D 04LL/NPT	1/8"NPT
6	100	D 06RLL	R 1/8"K	D 06MLL	M 10x1K	D 06LL/NPT	1/8"NPT
8		D 08RLL	R 1/8"K	D 08MLL	M 10x1K	D 08LL/NPT	1/8"NPT
6		L 315	D 06RL	R 1/8"K	D 06ML	M 10x1K	D 06L/NPT
8	DC 08RL		R 1/4"K	D 08ML	M 12x1,5K	D 08L/NPT	1/4"NPT
10	D 10RL		R 1/4"K	D 10ML	M 14x1,5K	D 10L/NPT	1/4"NPT
12	D 12RL		R 3/8"K	D 12ML	M 16x1,5K	D 12L/NPT	3/8"NPT
15	D 15RL		R 1/2"K	D 15ML	M 18x1,5K	D 15L/NPT	1/2"NPT
18	D 18RL		R 1/2"K	D 18ML	M 22x1,5K	D 18L/NPT	1/2"NPT
22	L 160		D 22RL	G 3/4"	D 22ML	M 26x1,5	D 22L/NPT
28		D 28RL	G 1"	D 28ML	M 33x2	D 28L/NPT	1"NPT
35		D 35RL	G 1 1/4"	D 35ML	M 42x2	D 35L/NPT	1 1/4"NPT
42		D 42RL	G 1 1/2"	D 42ML	M 48x2	D 42L/NPT	1 1/2"NPT
6	S 400	D 06RS	R 1/4"K	D 06MS	M 12x1,5K	D 06S/NPT	1/4"NPT
8		D 08RS	R 1/4"K	D 08MS	M 14x1,5K	D 08S/NPT	1/4"NPT
10		D 10RS	R 3/8"K	D 10MS	M 16x1,5K	D 10S/NPT	3/8"NPT
12		D 12RS	R 3/8"K	D 12MS	M 18x1,5K	D 12S/NPT	3/8"NPT
14		D 14RS	R 1/2"K	D 14MS	M 20x1,5K	D 14S/NPT	1/2"NPT
16	S 250	D 16RS	R 1/2"K	D 16MS	M 22x1,5K	D 16S/NPT	1/2"NPT
20		D 20RS	R 3/4"K	D 20MS	M 27x2	D 20S/NPT	3/4"NPT
25		D 25RS	G 1"	D 25MS	M 33x2	D 25S/NPT	1"NPT
30	S 160	D 30RS	G 1 1/4"	D 30MS	M 42x2	D 30S/NPT	1 1/4"NPT
38		D 38RS	G 1 1/2"	D 38MS	M 48x2	D 38S/NPT	1 1/2"NPT

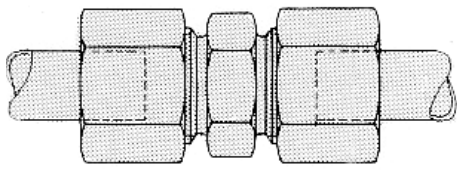

E – spojka přímá

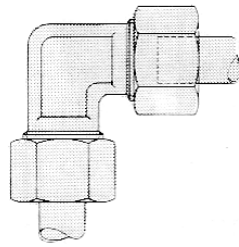

F – spojka úhlová

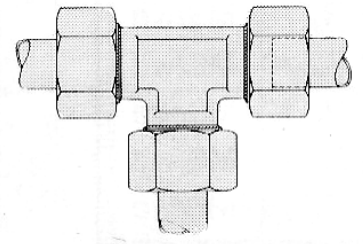

G – T spojka

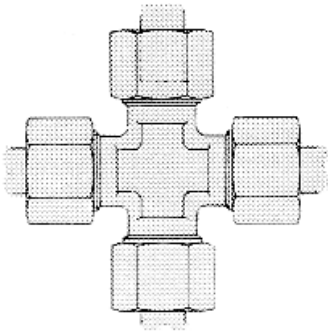

H – spojka křížová

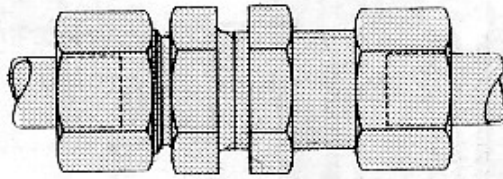

K – spojka přímá prodloužená

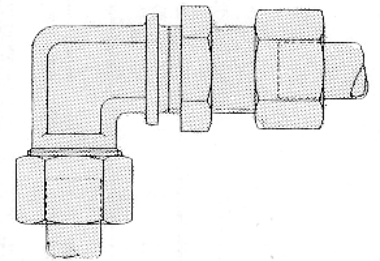

L – spojka úhlová prodloužená

AD	PN	Obj. kód	Obj. kód	Obj. kód	Obj. kód	Obj. kód	Obj. kód
4	LL	E 04LL	F 04LL	G 04LL			
6	100	E 06LL	F 06LL	G 06LL			
8		E 08LL	F 08LL	G 08LL			
6	L	E 06L	F 06L	G 06L	H 06L	K 06L	L 06L
8	500	E 08L	F 08L	G 10L	H 08L	K 08L	L 08L
10		E 10L	F 10L	G 10L	H 10L	K 10L	L 10L
12		E 12L	F 12L	G 12L	H 12L	K 12L	L 12L
15	L	E 15L	F 15L	G 15L	H 15L	K 15L	L 15L
18	400	E 18L	F 18L	G 18L	H 18L	K 18L	L 18L
22	L	E 22L	F 22L	G 22L	H 22L	K 22L	L 22L
28	250	E 28L	F 28L	G 28L	H 28L	K 28L	L 28L
35		E 35L	F 35L	G 35L	H 35L	K 35L	L 35L
42		E 42L	F 42L	G 42L	H 42L	K 42L	L 42L
6	S	E 06S	F 06S	G 06S	H 06S	K 06S	L 06S
8	800	E 08S	F 08S	G 08S	H 08S	K 08S	L 08S
10		E 10S	F 10S	G 10S	H 10S	K 10S	L 10S
12	S	E 12S	F 12S	G 12S	H 12S	K 12S	L 12S
14	630	E 14S	F 14S	G 14S	H 14S	K 14S	L 14S
16		E 16S	F 16S	G 16S	H 16S	K 16S	L 16S
20	S	E 20S	F 20S	G 20S	H 20S	K 20S	L 20S
25	400	E 25S	F 25S	G 25S	H 25S	K 25S	L 25S
30		E 30S	F 30S	G 30S	H 30S	K 30S	L 30S
38		E 38S	F 38S	G 38S	H 38S	K 38S	L 38S

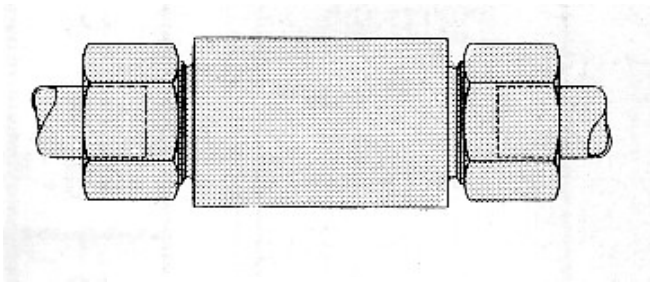

N – spojka navařovací

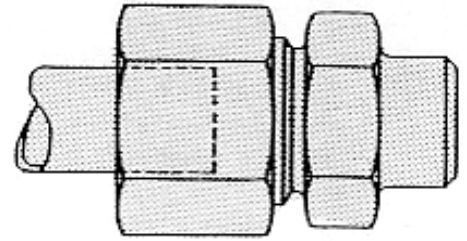

V – hrdlo navařovací

AD	PN	Obj. kód	Obj. kód
4	LL		
6	100		
8			
6	L 500	N 06L	V 06L
8		N 08L	V 08L
10		N 10L	V 10L
12		N 12L	V 12L
15	L 400	N 15L	V 15L
18		N 18L	V 18L
22	L 250	N 22L	V 22L
28		N 28L	V 28L
35		N 35L	V 35L
42		N 42L	V 42L
6	S 800	N 06S	V 06S
8		N 08S	V 08S
10		N 10S	V 10S
12	S 630	N 12S	V 12S
14		N 14S	V 14S
16		N 16S	V 16S
20	S 400	N 20S	V 20S
25		N 25S	V 25S
30		N 30S	V 30S
38		N 38S	V 38S

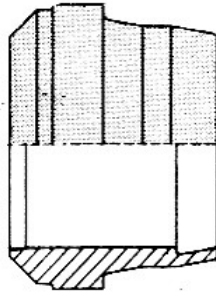

M – převlečená matice

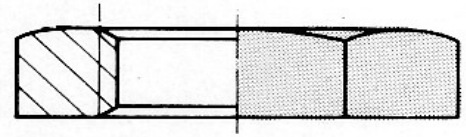

GM – kontra matice

DS – zářezný prstýnek

AD	PN	Obj. kód	Obj. kód
4	LL	M 04LL	S 04LL
6	100	M 06LL	S 06LL
8		M 08LL	S 08LL
6		M 06L	DS 06L
8	L	M 08L	DS 08L
10	500	M 10L	DS 10L
12		M 12L	DS 12L
15	L	M 15L	DS 15L
18	400	M 18L	DS 18L
22		M 22L	DS 22L
28	L	M 28L	DS 28L
35	250	M 35L	DS 35L
42		M 42L	DS 42L
6	S	M 06S	DS 06S
8	800	M 08S	DS 08S
10		M 10S	DS 10S
12	S	M 12S	DS 12S
14	630	M 14S	DS 14S
16		M 16S	DS 16S
20		M 20S	DS 20S
25	S	M 25S	DS 25S
30	400	M 30S	DS 30S
38		M 38S	DS 38S

Závit	Obj. kód
M 12x1,5	GM 06L
M 14x1,5	GM 06S/08L
M 16x1,5	GM 08S/10L
M 18x1,5	GM 10S/12L
M 20x1,5	GM 12S
M 22x1,5	GM 14S/15L
M 24x1,5	GM 16S
M 26x1,5	GM 18L
M 30x2	GM 20S/22L
M 36x2	GM 25S/28L
M 42x2	GM 30S
M 45x2	GM 35L
M 52x2	GM 38S/42L

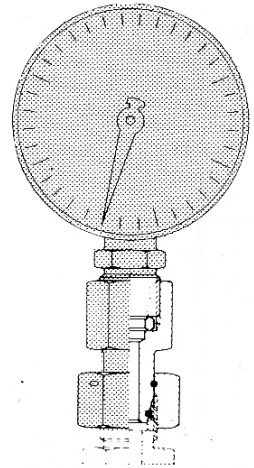
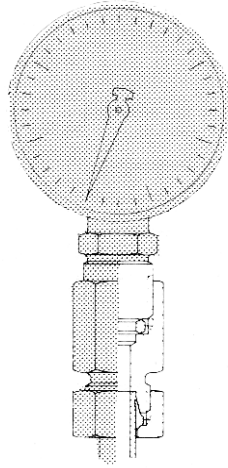
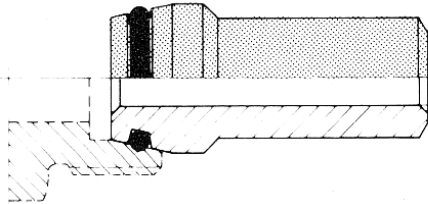

SNO – navařovací kuželka

O – přípojka na manometr

VODKO – přípojka na manometr

AD	PN	Rozměr trubky	Obj. kód
6	800	6x2	SNO 6x2
8	800	6x2,5	SNO 6x2,5
10	800	10x2	SNO 10x2
10	800	10x2,5	SNO 10x2,5
10	800	10x3	SNO 10x3
12	630	12x2	SNO 12x2
12	630	12x2,5	SNO 12x2,5
12	630	12x3	SNO 12x3
12	630	12x3,5	SNO 12x3,5
16	630	16x2	SNO 16x2
16	630	16x2,5	SNO 16x2,5
16	630	16x3	SNO 16x3
20	400	20x3	SNO 20x3
20	400	20x3,5	SNO 20x3,5
20	400	20x4	SNO 20x4
25	400	25x3	SNO 25x3
25	400	25x4	SNO 25x4
25	400	25x5	SNO 25x5
30	400	30x4	SNO 30x4
30	400	30x5	SNO 30x5
30	400	30x6	SNO 30x6
38	400	38x4	SNO 38x4
38	400	38x5	SNO 38x5
38	400	38x6	SNO 38x6
38	400	38x8	SNO 38x8

AD	PN	Obj. kód	G
6		O 06L	G 1/4"
8	L	O 08L	G 1/4"
10	500	O 10L	G 1/4"
12		O 12L	G 1/4"
6		O 6S	G 1/2"
8	S	O 8S	G 1/2"
10	800	O 10S	G 1/2"
12		O 12S	G 1/2"

AD	PN	Obj. kód	G
6		VODKO 06L	G 1/4"
8	L	VODKO 08L	G 1/4"
10	500	VODKO 10L	G 1/4"
12		VODKO 12L	G 1/4"
6		VODKO 6S	G 1/2"
8	S	VODKO 8S	G 1/2"
10	800	VODKO 10S	G 1/2"
12		VODKO 12S	G 1/2"

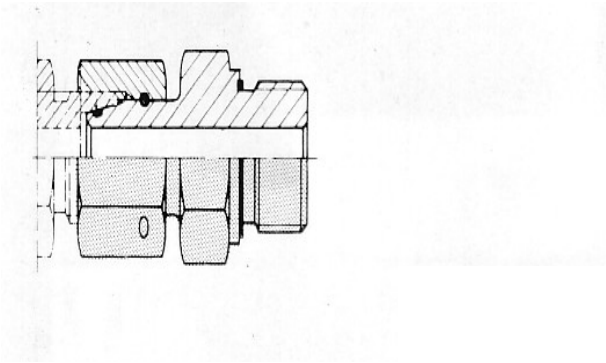

VADKO – stavitelné šroubení s O-kroužkem

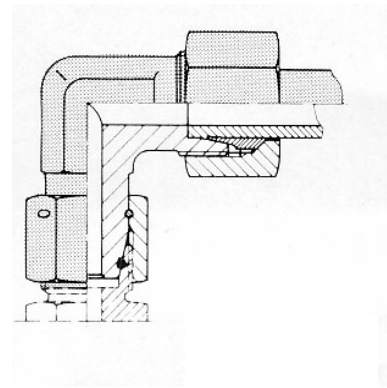

VBDKO – úhlové stavitelné šroubení s O-kroužkem

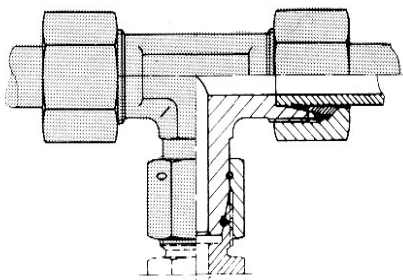

VCDKO – úhlové stavitelné šroubení s O-kroužkem

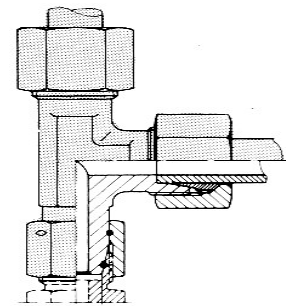

VDDKO úhlové stavitelné šroubení s O-kroužkem

AD	PN	Obj. kód	Obj. kód	Obj. kód	Obj. kód	G
6		VADKO 06RLWD	VBDKO 06RLWD	VCDKO 06RLWD	VDDKO 06RLWD	G 1/8"
8	L	VADKO 08RLWD	VBDKO 08RLWD	VCDKO 08RLWD	VDDKO 08RLWD	G 1/4"
10	500	VADKO 10RLWD	VBDKO 10RLWD	VCDKO 10RLWD	VDDKO 10RLWD	G 1/4"
12		VADKO 12RLWD	VBDKO 12RLWD	VCDKO 12RLWD	VDDKO 12RLWD	G 3/8"
15	L	VADKO 15RLWD	VBDKO 15RLWD	VCDKO 15RLWD	VDDKO 15RLWD	G 1/2"
18	400	VADKO 18RLWD	VBDKO 18RLWD	VCDKO 18RLWD	VDDKO 18RLWD	G 1/2"
22		VADKO 22RLWD	VBDKO 22RLWD	VCDKO 22RLWD	VDDKO 22RLWD	G 3/4"
28	L	VADKO 28RLWD	VBDKO 28RLWD	VCDKO 28RLWD	VDDKO 28RLWD	G 1"
35	250	VADKO 35RLWD	VBDKO 35RLWD	VCDKO 35RLWD	VDDKO 35RLWD	G 1 1/4"
42		VADKO 42RLWD	VBDKO 42RLWD	VCDKO 42RLWD	VDDKO 42RLWD	G 1 1/2"
6	S	VADKO 06RSWD	VBDKO 06RSWD	VCDKO 06RSWD	VDDKO 06RSWD	G 1/4"
8	800	VADKO 08RSWD	VBDKO 08RSWD	VCDKO 08RSWD	VDDKO 08RSWD	G 1/4"
10		VADKO 10RSWD	VBDKO 10RSWD	VCDKO 10RSWD	VDDKO 10RSWD	G 3/8"
12	S	VADKO 12RSWD	VBDKO 12RSWD	VCDKO 12RSWD	VDDKO 12RSWD	G 3/8"
14	630	VADKO 14RSWD	VBDKO 14RSWD	VCDKO 14RSWD	VDDKO 14RSWD	G 1/2"
16		VADKO 16RSWD	VBDKO 16RSWD	VCDKO 16RSWD	VDDKO 16RSWD	G 1/2"
20		VADKO 20RSWD	VBDKO 20RSWD	VCDKO 20RSWD	VDDKO 20RSWD	G 3/4"
25	S	VADKO 25RSWD	VBDKO 25RSWD	VCDKO 25RSWD	VDDKO 25RSWD	G 1"
30	400	VADKO 30RSWD	VBDKO 30RSWD	VCDKO 30RSWD	VDDKO 30RSWD	G 1 1/4"
38		VADKO 38RSWD	VBDKO 38RSWD	VCDKO 38RSWD	VDDKO 38RSWD	G 1 1/2"
6		VADKO 06MLWD	VBDKO 06MLWD	VCDKO 06MLWD	VDDKO 06MLWD	M 10x1
8	L	VADKO 08MLWD	VBDKO 08MLWD	VCDKO 08MLWD	VDDKO 08MLWD	M 12x1,5
10	500	VADKO 10MLWD	VBDKO 10MLWD	VCDKO 10MLWD	VDDKO 10MLWD	M 14x1,5
12		VADKO 12MLWD	VBDKO 12MLWD	VCDKO 12MLWD	VDDKO 12MLWD	M 16x1,5
15	L	VADKO 15MLWD	VBDKO 15MLWD	VCDKO 15MLWD	VDDKO 15MLWD	M 18x1,5
18	400	VADKO 18MLWD	VBDKO 18MLWD	VCDKO 18MLWD	VDDKO 18MLWD	M 22x1,5
22		VADKO 22MLWD	VBDKO 22MLWD	VCDKO 22MLWD	VDDKO 22MLWD	M 26x1,5
28	L	VADKO 28MLWD	VBDKO 28MLWD	VCDKO 28MLWD	VDDKO 28MLWD	M 33x2
35	250	VADKO 35MLWD	VBDKO 35MLWD	VCDKO 35MLWD	VDDKO 35MLWD	M 42x2
42		VADKO 42MLWD	VBDKO 42MLWD	VCDKO 42MLWD	VDDKO 42MLWD	M 48x2
6	S	VADKO 06MSWD	VBDKO 06MSWD	VCDKO 06MSWD	VDDKO 06MSWD	M 12x1,5
8	800	VADKO 08MSWD	VBDKO 08MSWD	VCDKO 08MSWD	VDDKO 08MSWD	M 14x1,5
10		VADKO 10MSWD	VBDKO 10MSWD	VCDKO 10MSWD	VDDKO 10MSWD	M 16x1,5
12	S	VADKO 12MSWD	VBDKO 12MSWD	VCDKO 12MSWD	VDDKO 12MSWD	M 18x1,5
14	630	VADKO 14MSWD	VBDKO 14MSWD	VCDKO 14MSWD	VDDKO 14MSWD	M 20x1,5
16		VADKO 16MSWD	VBDKO 16MSWD	VCDKO 16MSWD	VDDKO 16MSWD	M 22x1,5
20		VADKO 20MSWD	VBDKO 20MSWD	VCDKO 20MSWD	VDDKO 20MSWD	M 27x2
25	S	VADKO 25MSWD	VBDKO 25MSWD	VCDKO 25MSWD	VDDKO 25MSWD	M 33x2
30	400	VADKO 30MSWD	VBDKO 30MSWD	VCDKO 30MSWD	VDDKO 30MSWD	M 42x2
38		VADKO 38MSWD	VBDKO 38MSWD	VCDKO 38MSWD	VDDKO 38MSWD	M 48x2

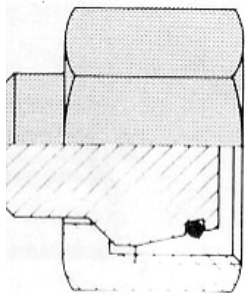

STO - zátka s O-kroužkem

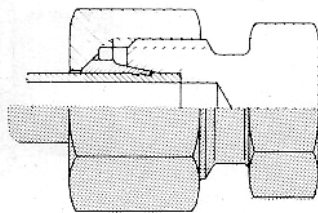

VSCHK - zátka

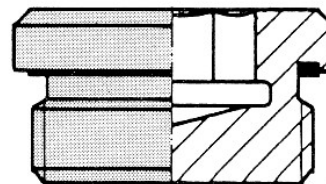

VSCH - zátka

AD	PN	Obj. kód	Obj. kód
6		STO 06L	VSCHK 06L
8	L	STO 08L	VSCHK 08L
10	500	STO 10L	VSCHK 10L
12		STO 12L	VSCHK 12L
15	L	STO 15L	VSCHK 15L
18	400	STO 18L	VSCHK 18L
22		STO 22L	VSCHK 22L
28	L	STO 28L	VSCHK 28L
35	250	STO 35L	VSCHK 35L
42		STO 42L	VSCHK 42L
6	S	STO 06S	VSCHK 06S
8	800	STO 08S	VSCHK 08S
10		STO 10S	VSCHK 10S
12	S	STO 12S	VSCHK 12S
14	630	STO 14S	VSCHK 14S
16		STO 16S	VSCHK 16S
20		STO 20S	VSCHK 20S
25	S	STO 25S	VSCHK 25S
30	400	STO 30S	VSCHK 30S
38		STO 38S	VSCHK 38S

PN	M / G	Obj. kód
400	M 10x1	VSCH 10x1WD
	M 12x1,5	VSCH 12x1,5WD
	M 14x1,5	VSCH 14x1,5WD
	M 16x1,5	VSCH 16x1,5WD
	M 18x1,5	VSCH 18x1,5WD
	M 20x1,5	VSCH 20x1,5WD
	M 22x1,5	VSCH 22x1,5WD
	M 26x1,5	VSCH 26x1,5WD
	M 27x2	VSCH 27x2WD
	M 33x2	VSCH 33x2WD
250	M 42x2	VSCH 42x2WD
	M 48x2	VSCH 48x2WD
400	G 1/8"	VSCH R1/8"WD
	G 1/4"	VSCH R1/4"WD
	G 3/8"	VSCH R3/8"WD
	G 1/2"	VSCH R1/2"WD
	G 3/4"	VSCH R3/4"WD
	G 1"	VSCH R1"WD
250	G 1 1/4"	VSCH R11/4"WD
	G 1 1/2"	VSCH R11/2"WD

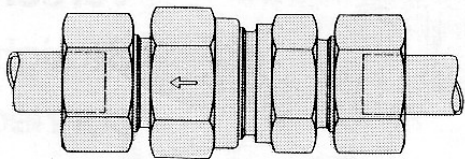

RD – zpětný ventil

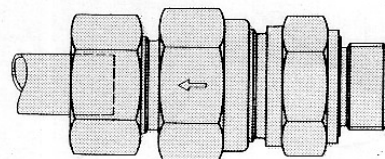

RV - zpětný ventil

AD	PN	Obj. kód	Obj. kód	G	Obj. kód	Obj. kód
6	L 400	RD 06L	RV 06RLWD	G 1/8"	RV 06MLWD	M 10x1
8		RD 08L	RV 08RLWD	G 1/4"	RV 08MLWD	M 12x1,5
10		RD 10L	RV 10RLWD	G 1/4"	RV 10MLWD	M 14x1,5
12		RD 12L	RV 12RLWD	G 3/8"	RV 12MLWD	M 16x1,5
15		RD 15L	RV 15RLWD	G 1/2"	RV 15MLWD	M 18x1,5
18		RD 18L	RV 18RLWD	G 1/2"	RV 18MLWD	M 22x1,5
22	L 250	RD 22L	RV 22RLWD	G 3/4"	RV 22MLWD	M 26x1,5
28		RD 28L	RV 28RLWD	G 1"	RV 28MLWD	M 33x2
35		RD 35L	RV 35RLWD	G 1 1/4"	RV 35MLWD	M 42x2
42		RD 42L	RV 42RLWD	G 1 1/2"	RV 42MLWD	M 48x2
6	S 630	RD 06S	RV 06RSWD	G 1/4"	RV 06MSWD	M 12x1,5
8		RD 08S	RV 08RSWD	G 1/4"	RV 08MSWD	M 14x1,5
10		RD 10S	RV 10RSWD	G 3/8"	RV 10MSWD	M 16x1,5
12		RD 12S	RV 12RSWD	G 3/8"	RV 12MSWD	M 18x1,5
14		RD 14S	RV 14RSWD	G 1/2"	RV 14MSWD	M 20x1,5
16		RD 16S	RV 16RSWD	G 1/2"	RV 16MSWD	M 22x1,5
20	400	RD 20S	RV 20RSWD	G 3/4"	RV 20MSWD	M 27x2
25		RD 25S	RV 25RSWD	G 1"	RV 25MSWD	M 33x2
30	250	RD 30S	RV 30RSWD	G 1 1/4"	RV 30MSWD	M 42x2
38		RD 38S	RV 38RSWD	G 1 1/2"	RV 38MSWD	M 48x2

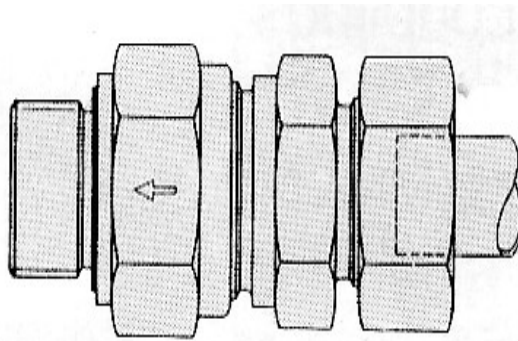

RZ – zpětný ventil

AD	PN	Obj. kód	Obj. kód	G	Obj. kód
6	L 400	RZ 06RLWD	G 1/8"	RZ 06MLWD	M 10x1
8		RZ 08RLWD	G 1/4"	RZ 08MLWD	M 12x1,5
10		RZ 10RLWD	G 1/4"	RZ 10MLWD	M 14x1,5
12		RZ 12RLWD	G 3/8"	RZ 12MLWD	M 16x1,5
15		RZ 15RLWD	G 1/2"	RZ 15MLWD	M 18x1,5
18		RZ 18RLWD	G 1/2"	RZ 18MLWD	M 22x1,5
22	L 250	RZ 22RLWD	G 3/4"	RZ 22MLWD	M 26x1,5
28		RZ 28RLWD	G 1"	RZ 28MLWD	M 33x2
35		RZ 35RLWD	G 1 1/4"	RZ 35MLWD	M 42x2
42		RZ 42RLWD	G 1 1/2"	RZ 42MLWD	M 48x2
6	S 630	RZ 06RSWD	G 1/4"	RZ 06MSWD	M 12x1,5
8		RZ 08RSWD	G 1/4"	RZ 08MSWD	M 14x1,5
10		RZ 10RSWD	G 3/8"	RZ 10MSWD	M 16x1,5
12		RZ 12RSWD	G 3/8"	RZ 12MSWD	M 18x1,5
14		RZ 14RSWD	G 1/2"	RZ 14MSWD	M 20x1,5
16		RZ 16RSWD	G 1/2"	RZ 16MSWD	M 22x1,5
20	400	RZ 20RSWD	G 3/4"	RZ 20MSWD	M 27x2
25		RZ 25RSWD	G 1"	RZ 25MSWD	M 33x2
30	250	RZ 30RSWD	G 1 1/4"	RZ 30MSWD	M 42x2
38		RZ 38RSWD	G 1 1/2"	RZ 38MSWD	M 48x2

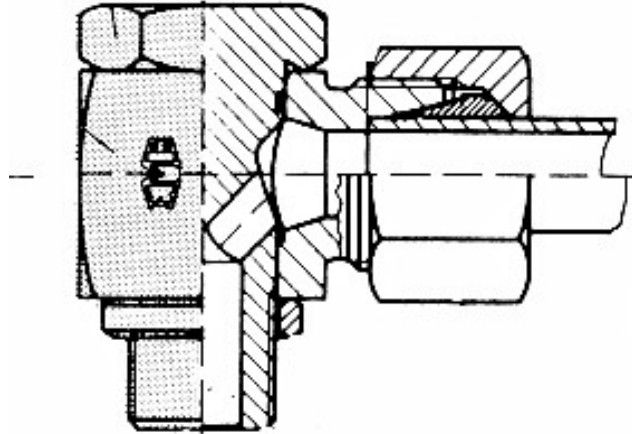

SBE – úhlové nastavitelné šroubení s měkkým těsněním

AD	PN	Obj. kód	Obj. kód	G	Obj. kód
6	L 400	SBE 06RLWD	G 1/8"	SBE 06MLWD	M 10x1
8		SBE 08RLWD	G 1/4"	SBE 08MLWD	M 12x1,5
10		SBE 10RLWD	G 1/4"	SBE 10MLWD	M 14x1,5
12		SBE 12RLWD	G 3/8"	SBE 12MLWD	M 16x1,5
15		SBE 15RLWD	G 1/2"	SBE 15MLWD	M 18x1,5
18		SBE 18RLWD	G 1/2"	SBE 18MLWD	M 22x1,5
22	L 250	SBE 22RLWD	G 3/4"	SBE 22MLWD	M 26x1,5
28		SBE 28RLWD	G 1"	SBE 28MLWD	M 33x2
35		SBE 35RLWD	G 1 1/4"	SBE 35MLWD	M 42x2
42		SBE 42RLWD	G 1 1/2"	SBE 42MLWD	M 48x2
6	S 630	SBE 06RSWD	G 1/4"	SBE 06MSWD	M 12x1,5
8		SBE 08RSWD	G 1/4"	SBE 08MSWD	M 14x1,5
10		SBE 10RSWD	G 3/8"	SBE 10MSWD	M 16x1,5
12		SBE 12RSWD	G 3/8"	SBE 12MSWD	M 18x1,5
14		SBE 14RSWD	G 1/2"	SBE 14MSWD	M 20x1,5
16		SBE 16RSWD	G 1/2"	SBE 16MSWD	M 22x1,5
20	400	SBE 20RSWD	G 3/4"	SBE 20MSWD	M 27x2
25		SBE 25RSWD	G 1"	SBE 25MSWD	M 33x2
30	250	SBE 30RSWD	G 1 1/4"	SBE 30MSWD	M 42x2
38		SBE 38RSWD	G 1 1/2"	SBE 38MSWD	M 48x2

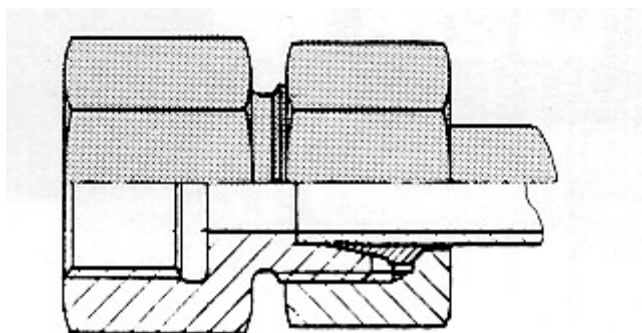

Ai – přímé hrdlo

AD	PN	Obj. kód	Obj. kód	G	Obj. kód
6		Ai 06LR1/8"	G 1/8"	Ai 06LM10x1	M 10x1
8		Ai 08LR1/4"	G 1/4"	Ai 08LM12x1,5	M 12x1,5
10	L	Ai 10LR1/4"	G 1/4"	Ai 10LM14x1,5	M 14x1,5
12	315	Ai 12LR3/8"	G 3/8"	Ai 12LM16x1,5	M 16x1,5
15		Ai 15LR1/2"	G 1/2"	Ai 15LM18x1,5	M 18x1,5
18		Ai 18LR1/2"	G 1/2"	Ai 18LM22x1,5	M 22x1,5
22		Ai 22LR3/4"	G 3/4"	Ai 22LM26x1,5	M 26x1,5
28	L	Ai 28LR1"	G 1"	Ai 28LM33x2	M 33x2
35	160	Ai 35LR1 1/4"	G 1 1/4"	Ai 35LM42x2	M 42x2
42		Ai 42LR1 1/2"	G 1 1/2"	Ai 42LM48x2	M 48x2
6		Ai 06SR1/4"	G 1/4"	Ai 06SM12x1,5	M 12x1,5
8		Ai 08SR1/4"	G 1/4"	Ai 08SM14x1,5	M 14x1,5
10	S	Ai 10SR3/8"	G 3/8"	Ai 10SM16x1,5	M 16x1,5
12	630	Ai 12SR3/8"	G 3/8"	Ai 12SM18x1,5	M 18x1,5
14		Ai 14SR1/2"	G 1/2"	Ai 14SM20x1,5	M 20x1,5
16		Ai 20SR1/2"	G 1/2"	Ai 16SM22x1,5	M 22x1,5
20	400	Ai 20SR3/4"	G 3/4"	Ai 20SM27x2	M 27x2
25		Ai 25SR1"	G 1"	Ai 25SM33x2	M 33x2
30		Ai 30SR1 1/4"	G 1 1/4"	Ai 30SM42x2	M 42x2
38	315	Ai 38SR1 1/2"	G 1 1/2"	Ai 38SM48x2	M 48x2

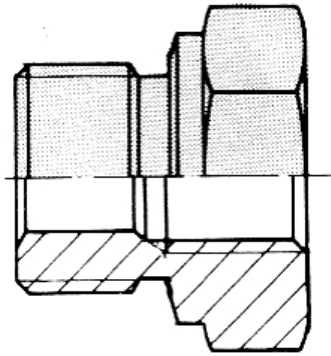

RI - redukce

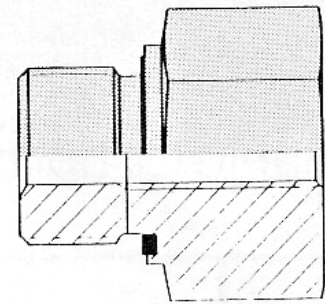

RI...-/WD - redukce

G	Obj. kód	G	Obj. kód	G	Obj. kód	G	Obj. kód
G3/8" R1/8"	RI3/8-1/8	G1/8" R1/4"	RI1/8-1/4	G3/8" R1/8"	RI3/8WD-1/8	G1/8" R1/4"	RI1/8WD-1/4
G1/2" R1/4"	RI1/2-1/4	G1/8" R3/8"	RI1/8-3/8	G1/2" R1/4"	RI1/2WD-1/4	G1/8" R3/8"	RI1/8WD-3/8
G3/4" R1/4"	RI3/4-1/4	G1/4" R1/8"	RI1/4-1/8	G3/4" R1/4"	RI3/4WD-1/4	G1/4" R1/8"	RI1/4WD-1/8
G3/4" R3/8"	RI3/4-3/8	G1/4" R3/8"	RI1/4-3/8	G3/4" R3/8"	RI3/4WD-3/8	G1/4" R3/8"	RI1/4WD-3/8
G1" R1/4"	RI1-1/4	G1/4" R1/2"	RI1/4-1/2	G1" R1/4"	RI1WD-1/4	G1/4" R1/2"	RI1/4WD-1/2
G1" R3/8"	RI1-3/8	G1/4" R3/4"	RI1/4-3/4	G1" R3/8"	RI1WD-3/8	G1/4" R3/4"	RI1/4WD-3/4
G1" R1/2"	RI1-1/2	G3/8" R1/4"	RI3/8-1/4	G1" R1/2"	RI1WD-1/2	G3/8" R1/4"	RI3/8WD-1/4
G1 1/4" G1/2"	RI1 1/4-1/2	G3/8" R1/2"	RI3/8-1/2	G1 1/4" G1/2"	RI1 1/4WD-1/2	G3/8" R1/2"	RI3/8WD-1/2
G1 1/4" R3/4"	RI1 1/4-3/4	G3/8" R3/4"	RI3/8-3/4	G1 1/4" R3/4"	RI1 1/4WD-3/4	G3/8" R3/4"	RI3/8WD-3/4
G1 1/2" R1/2"	RI1 1/2-1/2	G1/2" R3/8"	RI1/2-3/8	G1 1/2" R1/2"	RI1 1/2WD-1/2	G1/2" R3/8"	RI1/2WD-3/8
G1 1/2" R3/4"	RI1 1/2-3/4	G1/2" R3/4"	RI1/2-3/4	G1 1/2" R3/4"	RI1 1/2WD-3/4	G1/2" R3/4"	RI1/2WD-3/4
G1 1/2" R1"	RI1 1/2-1	G1/2" R1"	RI1/2-1	G1 1/2" R1"	RI1 1/2WD-1	G1/2" R1"	RI1/2WD-1
		G1/2" R1 1/4"	RI1/2-1 1/4			G1/2" R1 1/4"	RI1/2WD-1 1/4
		G3/4" R1/2"	RI3/4-1/2			G3/4" R1/2"	RI3/4WD-1/2
		G3/4" R1"	RI3/4-1			G3/4" R1"	RI3/4WD-1
		G3/4" R1 1/4"	RI3/4-1 1/4			G3/4" R1 1/4"	RI3/4WD-1 1/4
		G3/4" R1 1/2"	RI3/4-1 1/2			G3/4" R1 1/2"	RI3/4WD-1 1/2
		G1" R3/4"	RI1-3/4			G1" R3/4"	RI1WD-3/4
		G1" R1 1/4"	RI1-1 1/4			G1" R1 1/4"	RI1WD-1 1/4
		G1" R1 1/2"	RI1-1 1/2			G1" R1 1/2"	RI1WD-1 1/2
		G1 1/4" R1"	RI1 1/4-1			G1 1/4" R1"	RI1 1/4WD-1
		G1 1/4" R1 1/2"	RI1 1/4-1 1/2			G1 1/4" R1 1/2"	RI1 1/4WD-1 1/2
		G1 1/2" R1 1/4"	RI1 1/2-1 1/4			G1 1/2" R1 1/4"	RI1 1/2WD-1 1/4